

EN

FR

DE

IT

PL

ES

SV

NO

DK

FI

ZH

JA

KO

Resusci Anne

Airway Head Upgrade Kit

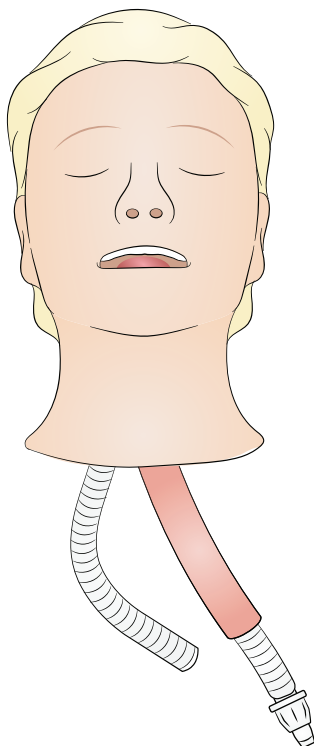



Resusci Anne Airway Head

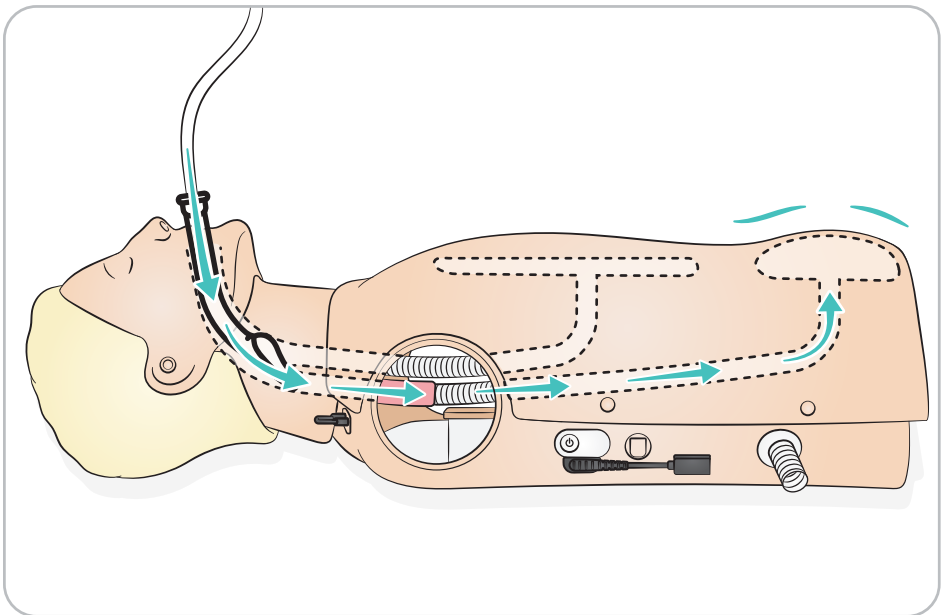
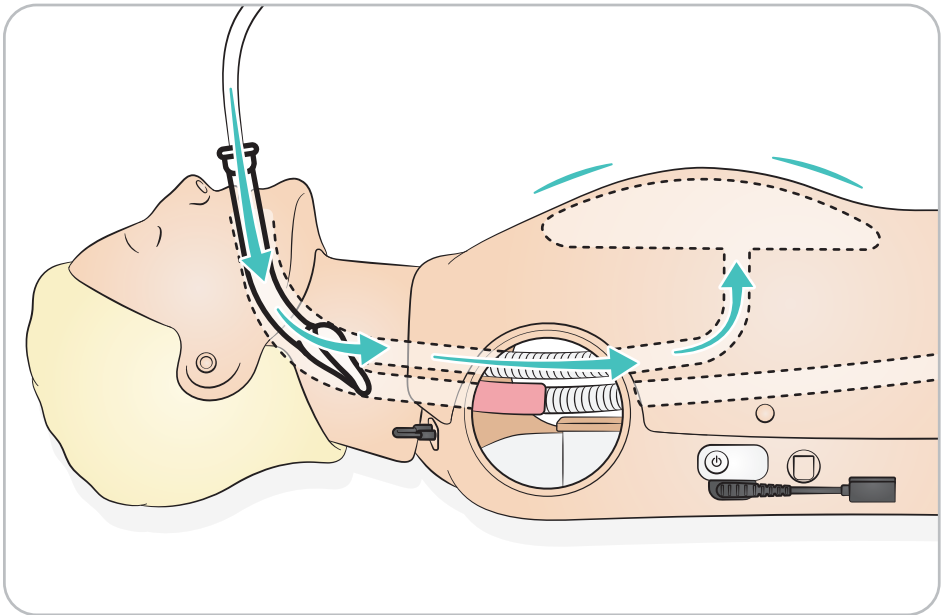



EN

- Perform airway management training with supraglottic devices.
- Identify stomach distension if intubation is performed incorrectly.

FR

- Formation sur la gestion des voies respiratoires avec des dispositifs supraglottiques.
- Identification d'un estomac distendu si l'intubation n'est pas correcte.

DE

- Für Airwaymanagementtraining mit supraglottischen Atemwegshilfen.
- Magenblähung bei falsch durchgeführter ösophagealer Intubation.

IT

- Eseguire il training per la gestione delle vie aeree con dispositivi per vie aeree sopraglottiche.
- Identificare la distensione dello stomaco se l'intubazione non è stata effettuata in modo corretto.

PL

- Możliwość szkolenia w zakresie postępowania z drogami oddechowymi z użyciem przyrządów do udroźniania dróg oddechowych.
- Możliwość rozpoznania rozdęcia żołądka w przypadku nieprawidłowej intubacji.

ES

- Realice la formación sobre gestión de la vía aérea con dispositivos supraglóticos.
- Identifique la distensión de estómago si la intubación no se realiza correctamente.

SV

- Öva på luftvägshantering och intubering med supraglottal utrustning.
- Möjlighet att kontrollera om buken är utspänd när intubering har utförts på fel sätt.

NO

- Utfør luftveistrening med supraglottiske enheter.
- Identifiserer mageoppblåsing hvis intubasjon utføres feil.

DK

- Gennemfør træning i luftvejshåndtering med supraglottiske enheder.
- Identificer udspiling af maven i tilfælde af forkert intubation.

FI

- Voit harjoitella hengitysteiden hallintaa supraglottisilla laitteilla.
- Huomaat vatsan laajentuvan, jos intubointi on tehty väärin.

ZH

- 利用声门上装置进行气道管理培训。
- 如果插管操作不当，识别胃胀气。

JA

- 气道管理トレーニングは声門上気道デバイスを使って行います。
- 挿管が適切でない場合、胃膨満により確認できます。

KO

- 성문위 장비로 기도 관리 교육을 수행하십시오.
- 삽관을 올바르게 수행하지 않았을 경우 위장관 팽창을 확인합니다.



Head Replacement

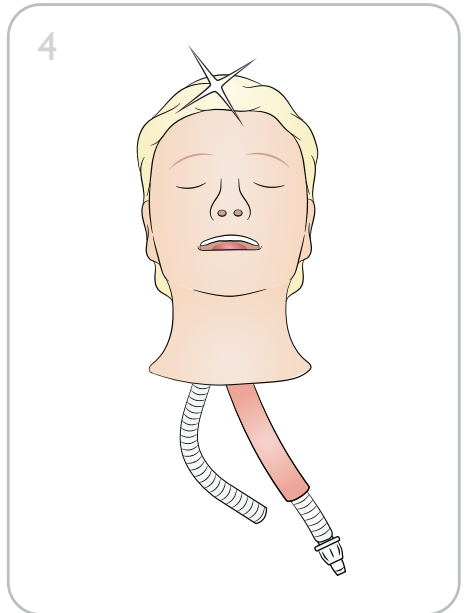
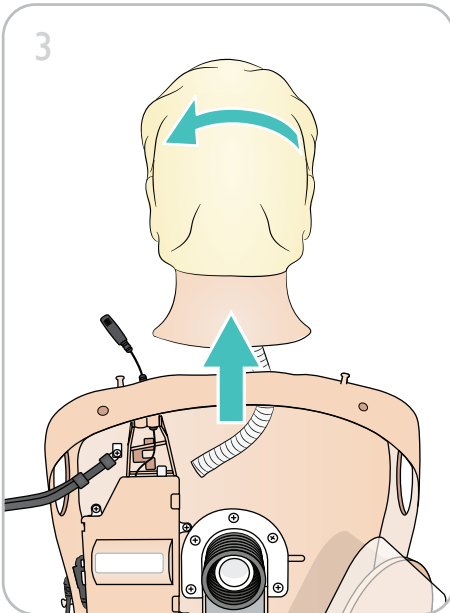
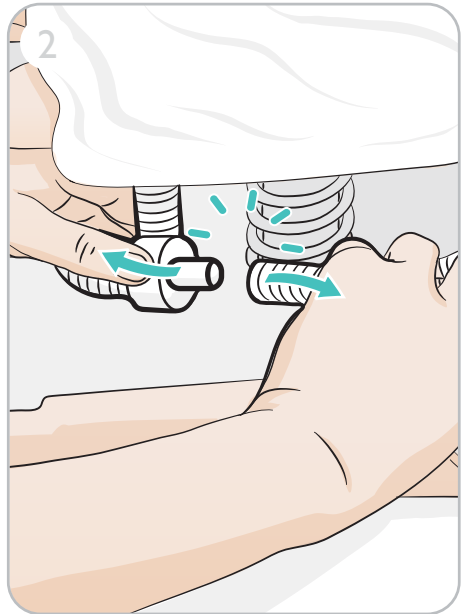
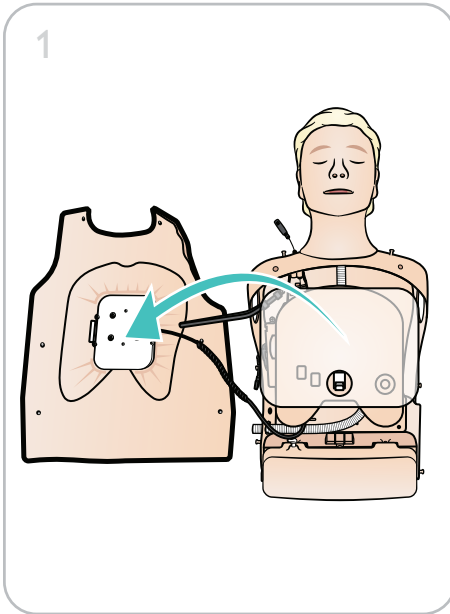

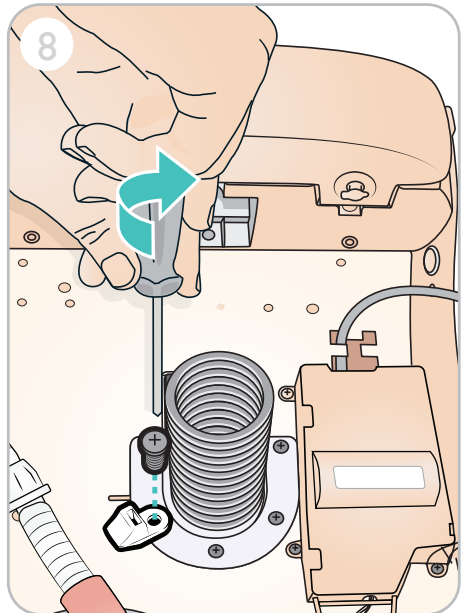
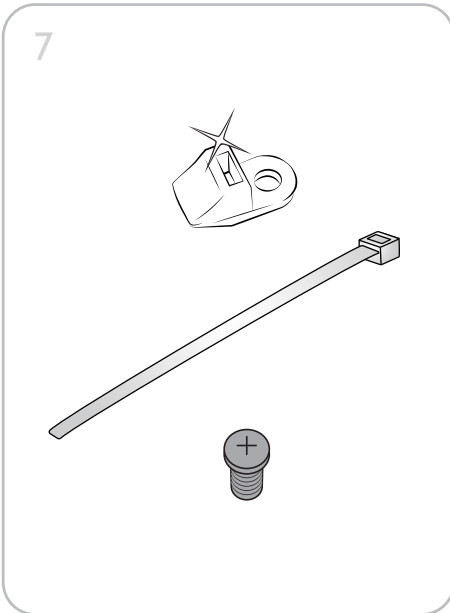
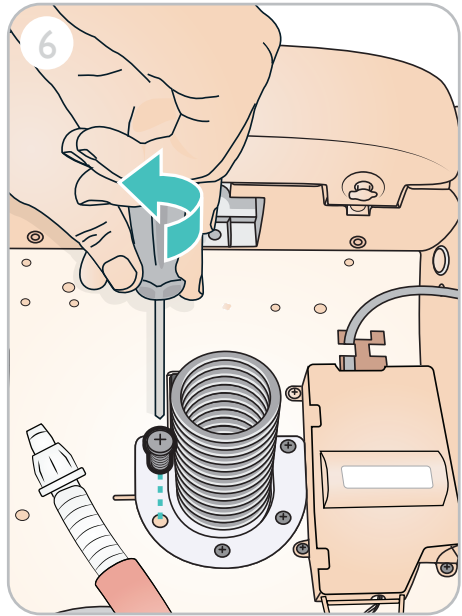
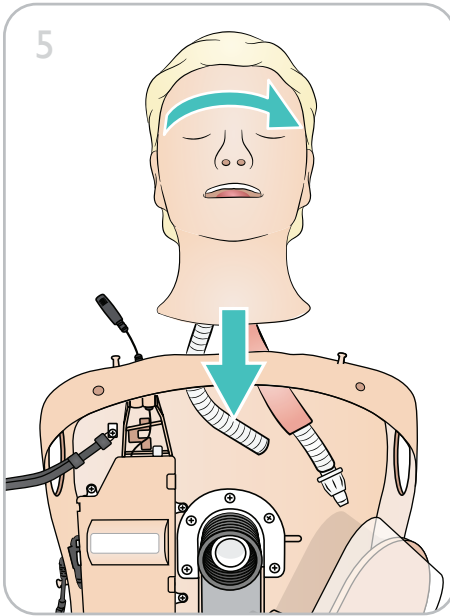



Head Replacement

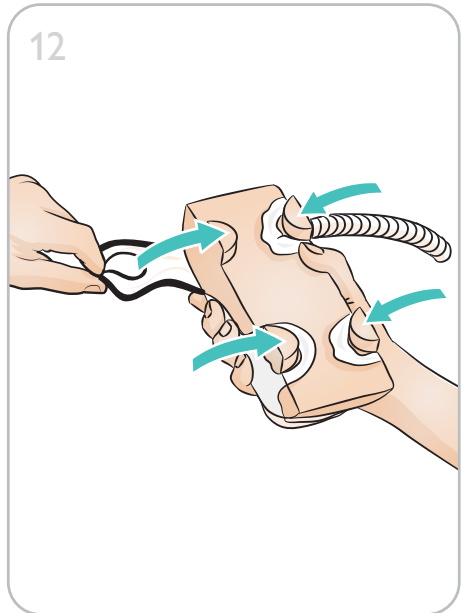
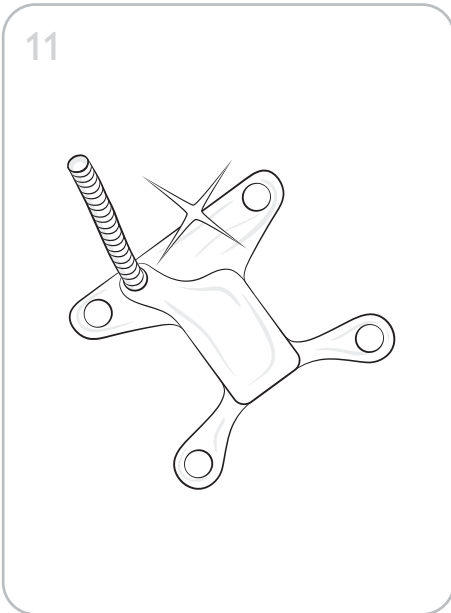
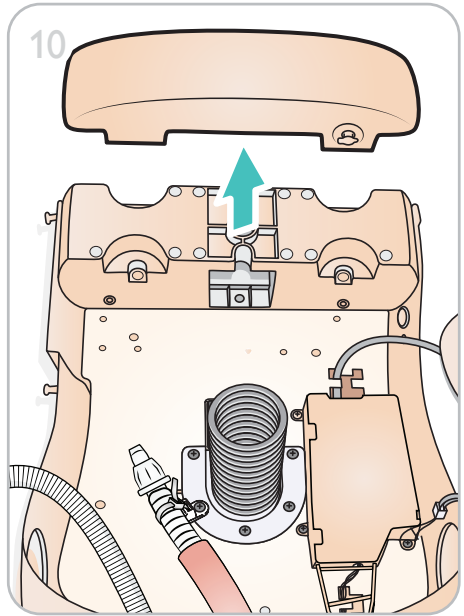
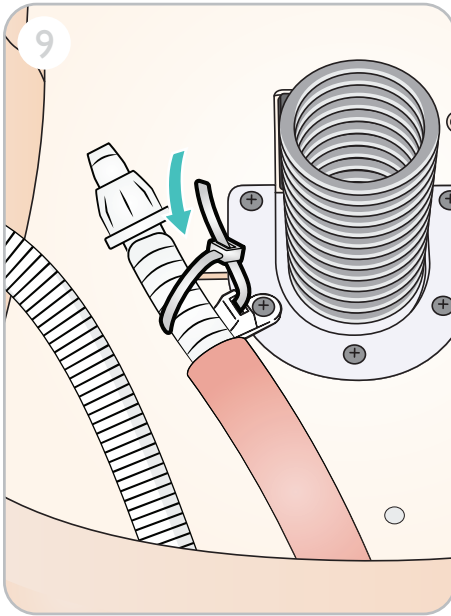

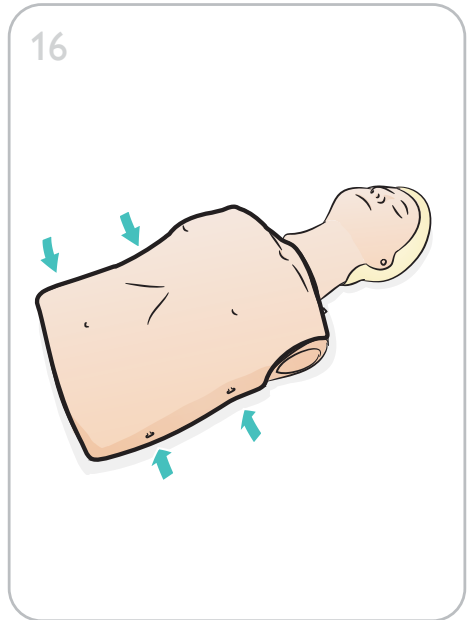
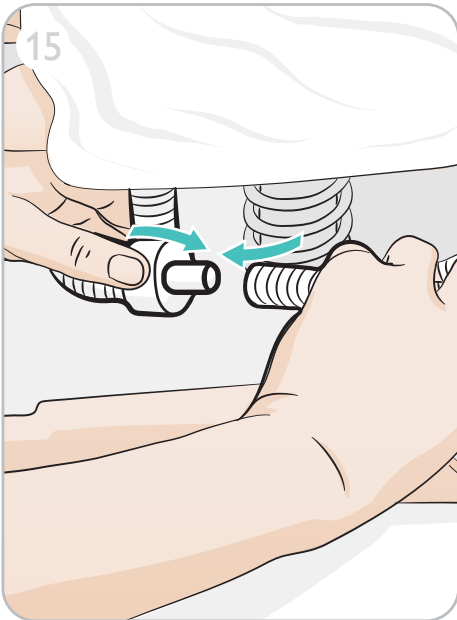
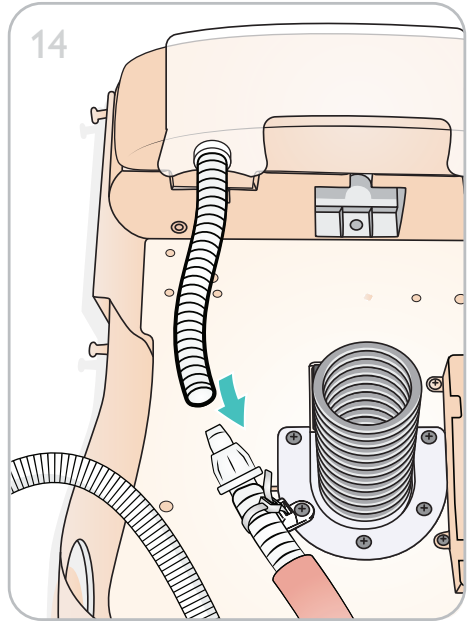
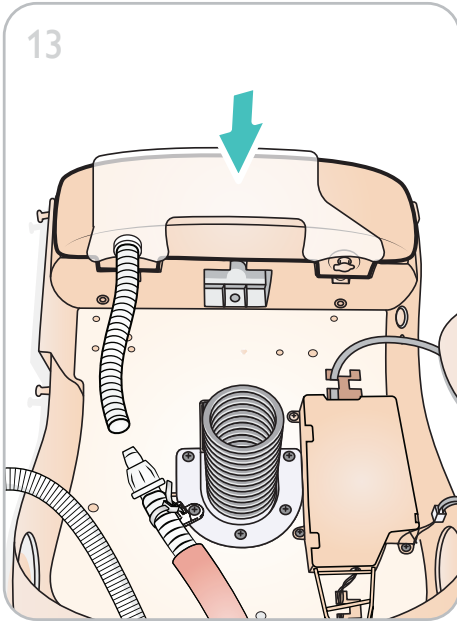



Lung Replacement

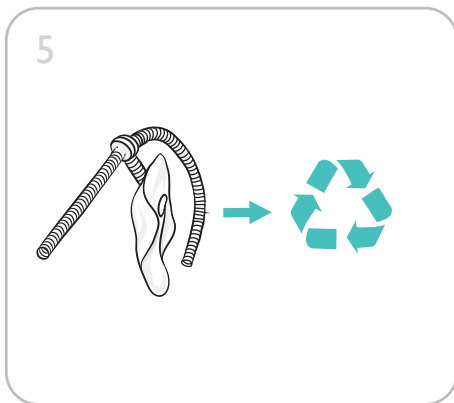
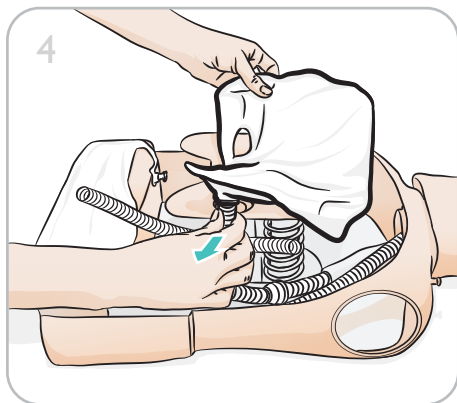
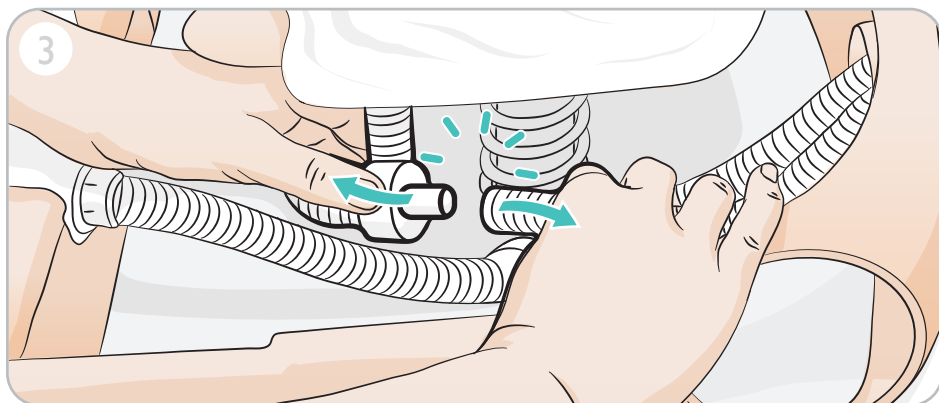
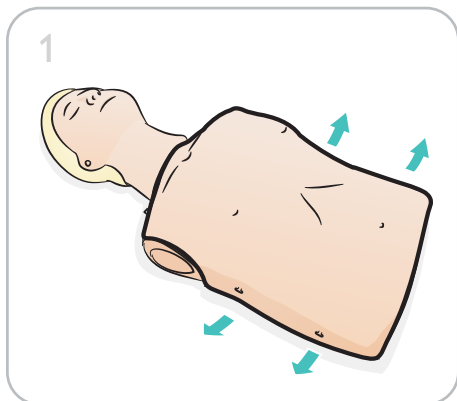

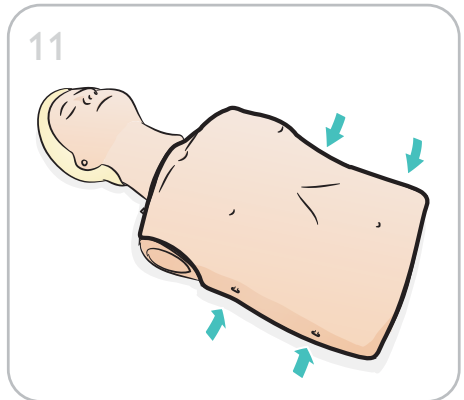
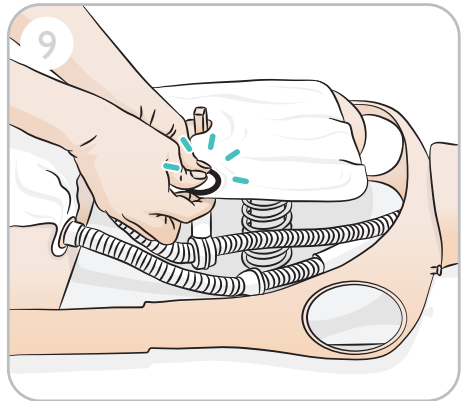
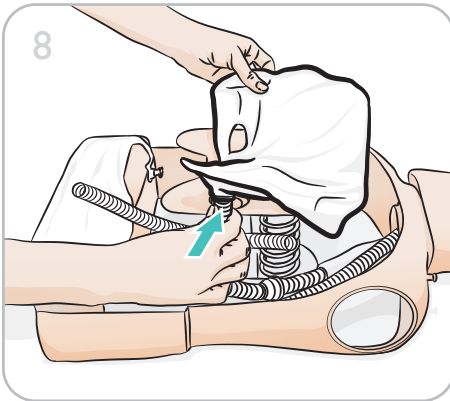
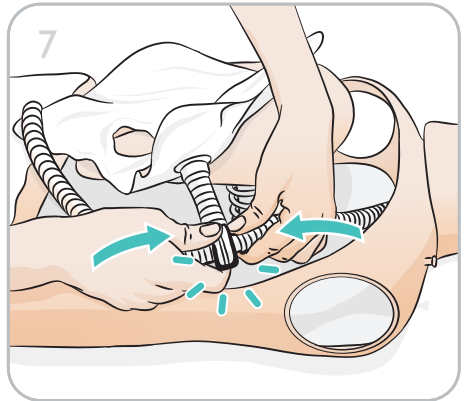
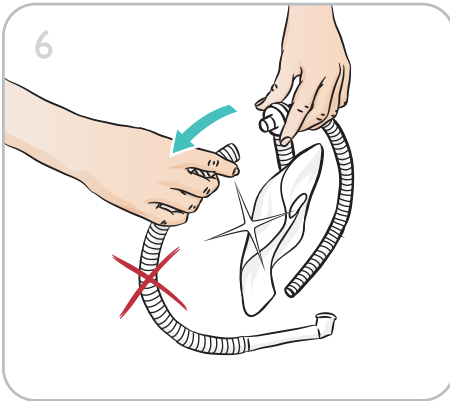



Stomach Replacement

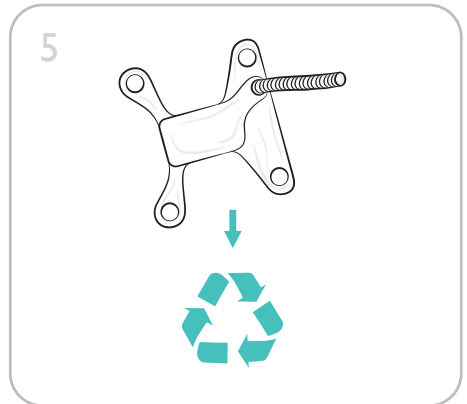
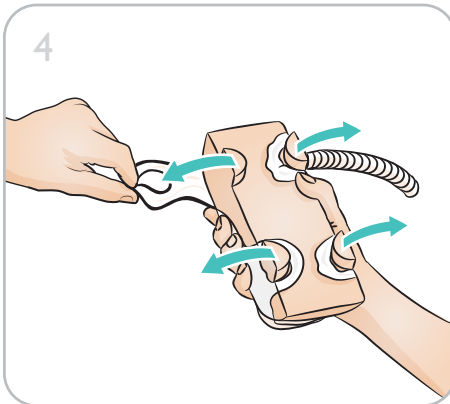
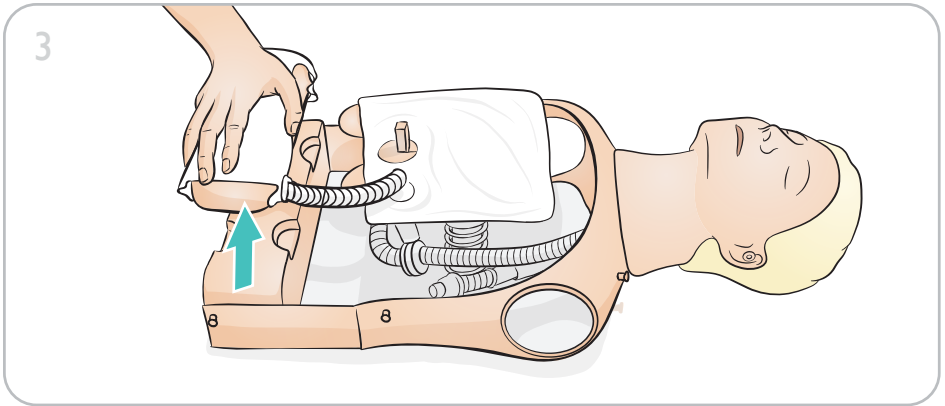
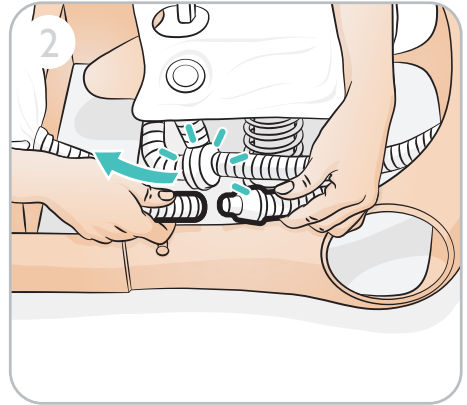
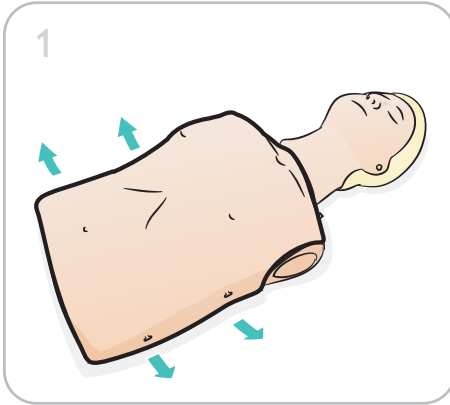

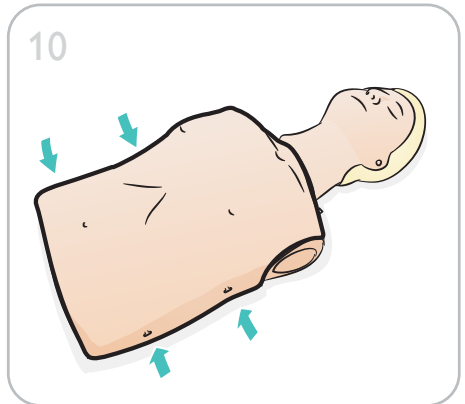
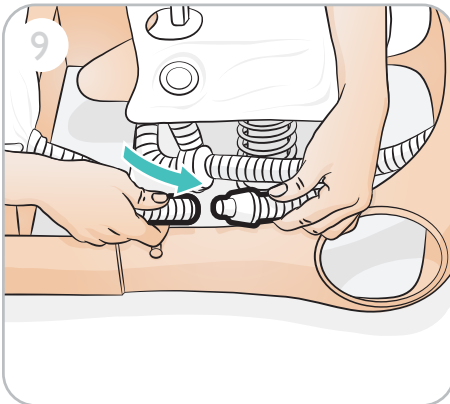
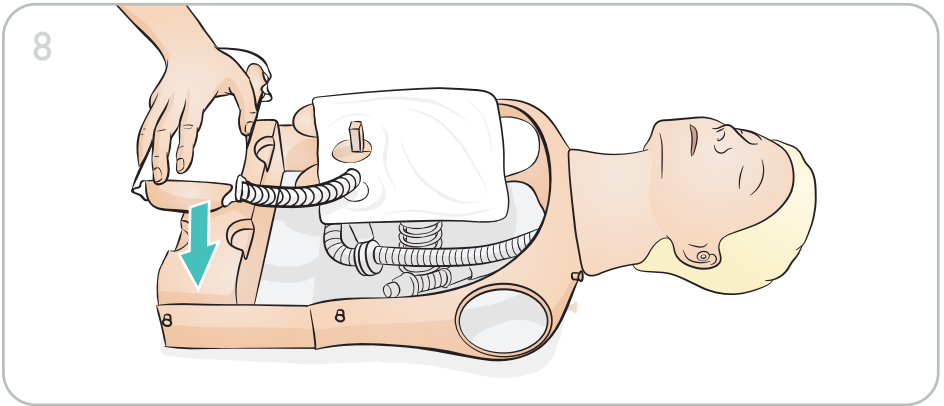
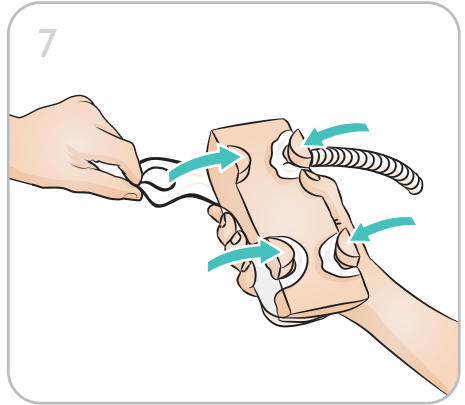
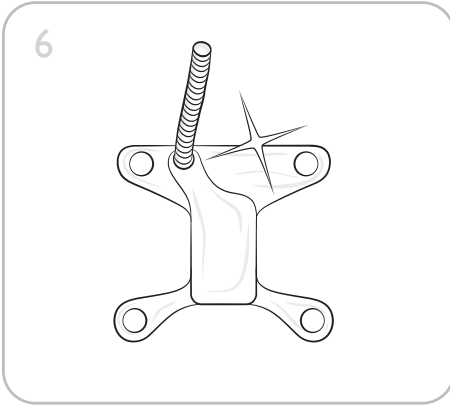



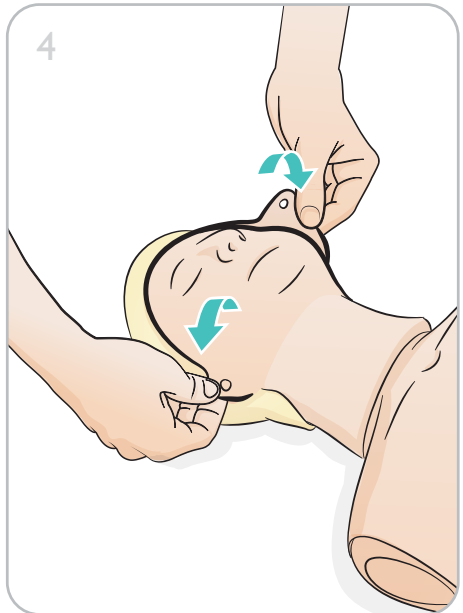
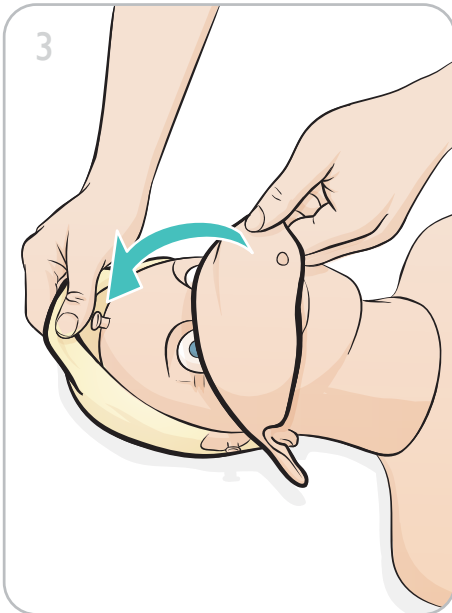
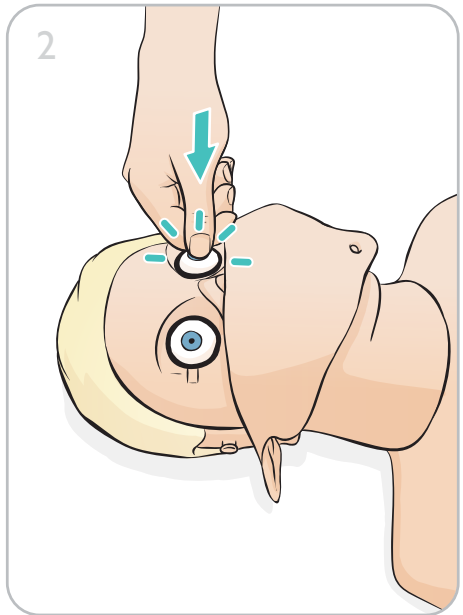
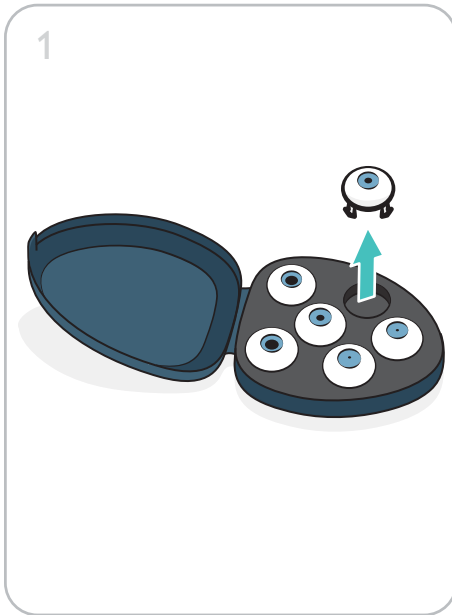

Eye Replacement

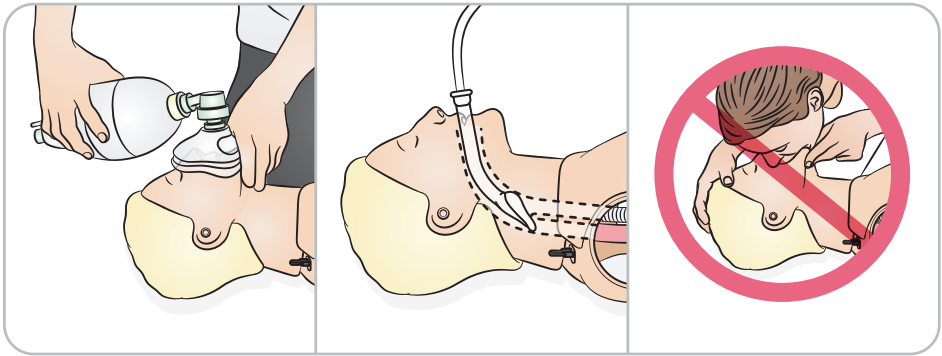



EN

Dimensions	
Weight	Approx. 3.18 kg (7 lbs)
Supported airway management tools	
I-Gel (size 5), LMA Classic (4 & 5), LMA Supreme (size 3), Laryngeal Tube LTS-D (size 3, 4 & 5), Japanese Sumi NA	
	Does not contain latex

 Cautions

- Use only Laerdal Airway Lubricant. Other lubricant not approved by Laerdal can damage the airway
- Lubricate instruments and tubes before insertion into the airway. Non-lubricated instruments and tubes are difficult to insert and can also damage the airway
- The airways in the Airway Head cannot be completely sanitised. Therefore do not perform:
 - Mouth-to-mouth ventilation
 - Mouth-to-mask ventilation
 - Insertion of simulated vomit for suctioning

Warranty

The Laerdal Resusci Anne Airway Head Upgrade Kit has a two-year limited Warranty. Refer to the Laerdal Global Warranty for terms and conditions.



Important Product Information

FR

Dimensions	
Poids	3.18 kg
Outils de gestion des voies respiratoires pris en charge	
I-Gel (taille 5), LMA Classic (4 & 5), LMA Supreme (taille 3), Laryngeal Tube LTS-D (tailles 3, 4 & 5), Japanese Sumi NA	
 Ce produit ne contient pas de latex.	

Garantie

Resusci Anne Airway Head Upgrade Kit de Laerdal bénéficie d'une garantie limitée de deux ans. Reportez-vous à la garantie mondiale de Laerdal pour en connaître les clauses.

Mises en garde

- *N'utilisez que le lubrifiant fourni par Laerdal Medical. L'utilisation de silicone ou d'autres lubrifiants non approuvés par Laerdal peut endommager les voies respiratoires.*
- *Lubrifiez les instruments et les tubulures avant l'insertion dans les voies respiratoires. L'insertion d'instruments et de tubes non lubrifiés dans les voies respiratoires est difficile. Les instruments et tubes non lubrifiés peuvent également endommager les voies respiratoires.*
- *Les voies respiratoires situées dans la tête de gestion des voies respiratoires ne peuvent pas être entièrement désinfectées. Par conséquent, ne réalisez pas :*
 - *de ventilation bouche-à-bouche*
 - *de ventilation bouche-à-masque*
 - *d'insertion de vomi factice pour aspiration*

DE

Abmessungen	
Gewicht	3.18 kg
Unterstützte Airway Management Tools	
I-Gel (größe 5), LMA Classic (4 & 5), LMA Supreme (größe 3), Laryngeal Tube LTS-D (größe 3, 4 & 5), Japanese Sumi NA	
 Enthält kein Latex.	

Garantie

Für das Laerdal Resusci Anne Airway Head Upgrade Kit gilt eine eingeschränkte Gewährleistung von zwei Jahren. Informationen zu den Gewährleistungsbedingungen finden Sie in der Broschüre über die weltweite Garantie von Laerdal.

Sicherheitshinweise

- *Nur das von Laerdal Medical erhältliche Gleitmittel verwenden. Die Verwendung von Silikon oder einem anderen, nicht von Laerdal freigegebenen Gleitmittel kann zu Schäden am Atemweg führen.*
- *Instrumente und Tuben vor dem Einführen in den Atemweg mit Gleitmittel behandeln. Die Intubation mit nicht mit Gleitmittel behandelten Instrumenten und Tuben ist erschwert. Nicht mit Gleitmittel behandelte Instrumente und Tuben können außerdem den Atemweg schädigen.*
- *Der Atemweg im Airway Kopf kann nicht vollständig desinfiziert werden, daher ist Folgendes zu unterlassen:*
 - *Mund-zu-Mund-Beatmung*
 - *Mund-zu-Maske-Beatmung*
 - *Eingeben von künstlichem Erbrochenen zum Absaugen*



IT

Dimensioni	
Peso	3.18 kg
Supporto per strumenti di gestione delle vie aeree	
I-Gel (taglia 5), LMA Classic (4 & 5), LMA Supreme (taglia 3), Laryngeal Tube LTS-D (taglia 3, 4 & 5), Japanese Sumi NA	
 Non contiene lattice.	

Garanzia

Il kit di aggiornamento della testa delle vie aeree Laerdal è coperto da una garanzia limitata di due anni. Per i termini e le condizioni, consultare la garanzia globale di Laerdal.

Precauzioni

- Usare esclusivamente il lubrificante fornito da Laerdal Medical. L'uso di silicone o altri lubrificanti non approvati da Laerdal potrebbe danneggiare le vie aeree.
- Lubrificare gli strumenti e i tubi prima di procedere all'inserimento nelle vie aeree. È difficile inserire strumenti e tubi non lubrificati nelle vie aeree. L'inserimento di strumenti o tubi non lubrificati potrebbe danneggiare le vie aeree.
- Poiché non è possibile sterilizzare totalmente la testa di gestione delle vie aeree, non eseguire:
 - ventilazione bocca a bocca
 - ventilazione bocca a maschera
 - inserimento di vomito finto per aspirazione

PL

Mitat	
Paino	3.18 kg
Obsługiwane przyrządy do udrażniania dróg oddechowych	
I-Gel (rozmiar 5), LMA Classic (4 & 5), LMA Supreme (rozmiar 3), Laryngeal Tube LTS-D (rozmiary 3, 4 & 5), Japanese Sumi NA	
 Nie zawiera lateksu.	

Gwarancja

Urządzenie Laerdal Resusci Anne Airway Head Upgrade Kit posiada dwuletnią ograniczoną gwarancję. Zasady i warunki gwarancji podano w Globalnej gwarancji firmy Laerdal.

Przestrogi

- Stosować wyłącznie środek nawilżający dostarczony przez firmę Laerdal Medical. Zastosowanie silikonu lub innych środków nawilżających niezatwierdzonych przez firmę Laerdal może spowodować uszkodzenie dróg oddechowych.
- Urządzenia i rurki należy nasmarować przed wprowadzeniem do dróg oddechowych. Nienasmarowane urządzenia i rurki trudno wprowadzić do dróg oddechowych. Nienasmarowane urządzenia i rurki mogą również uszkodzić drogi oddechowe.
- Drogi oddechowe w Airway Head nie mogą być całkowicie zdezynfekowane, dlatego nie wolno wykonywać:
 - Wentylacja usta-usta
 - Wentylacja usta-maską
 - Wprowadzania sztucznych wymiocin w celu wykonania odsysania



Important Product Information

ES

Dimensiones	
Peso	3.18 kg
Herramientas de manejo de la vía aérea compatibles	
I-Gel (tamaño 5), LMA Classic (4 & 5), LMA Supreme (tamaño 3), Laryngeal Tube LTS-D (tamaños 3, 4 & 5), Japanese Sumi NA	
 No contiene látex.	

Garantía

El kit de actualización Resusci Anne cabeza Instrumentalizada de Laerdal tiene una garantía limitada de dos años. Consulte la garantía global de Laerdal para ver los términos y las condiciones.

Precauciones

- *Utilice solamente el lubricante proporcionado por Laerdal Medical. Utilizar silicona u otro lubricante no aprobado por Laerdal puede dañar las vías respiratorias.*
- *Lubrique los instrumentos y los tubos antes de insertarlos en las vías aéreas. Es difícil insertar instrumentos y tubos no lubricados en las vías respiratorias. Los instrumentos y tubos no lubricados también pueden dañar las vías respiratorias.*
- *Las vías aéreas de la cabeza instrumentalizada no se pueden limpiar completamente, por tanto, no se debe:*
 - *Realizar la ventilación boca a boca*
 - *Realizar la ventilación boca-mascarilla*
 - *Insertar vómito simulado para succionamiento posterior*

SV

Mått	
Vikt	3.18 kg
Luftvägsbehandlingsutrustning som stöds	
I-Gel (storlek 5), LMA Classic (4 & 5), LMA Supreme (storlek 3), Laryngeal Tube LTS-D (storlek 3, 4 & 5), Japanese Sumi NA	
 Innehåller inte latex.	

Garanti

Laerdal Resusci Anne Airway Head Upgrade Kit har två års begränsad garanti. Information om garantivillkoren finns i Laerdals globala garanti – Laerdal Global Warranty.

Viktigt

- *Använd endast smörjmedel som tillhandahålls av Laerdal Medical. Luftvägarna kan skadas om silikon eller andra smörjmedel som inte har godkänts av Laerdal används.*
- *Smörj in instrument och tuber innan de förs in i luftvägarna. Det är svårt att föra in instrument och tuber i luftvägarna utan smörjmedel. Instrument och tuber som inte har smörjts in kan även skada luftvägarna.*
- *Det går inte att rengöra luftvägarna i luftvägshuvudet helt och hållet. Undvik därför:*
 - *mun-till-mun-andning*
 - *mun-till-mask-andning*
 - *applicering av simulerad kräkning för sugning*



NO

Dimensjoner	
Vekt	3.18 kg
Støttende redskap til luftveisbehandling	
I-Gel (størrelse 5), LMA Classic (4 & 5), LMA Supreme (størrelse 3), Laryngeal Tube LTS-D (størrelser 3, 4 & 5), Japanese Sumi NA	
	Inneholder ikke latex

Garanti

Laerdal Resusci Anne Airway Head Upgrade Kit har to års begrenset garanti. Se Laerdal Global Garanti for vilkår og betingelser.

Forsiktighetsregler

- Bruk kun smøremiddel som er anskaffet fra Laerdal, Medical. Bruk av silikon eller annet smøremiddel ikke godkjent av Laerdal kan skade luftveiene.
- Ta smøremiddel på instrumenter og slanger før innsetting i luftveiene. Det er vanskelig å sette inn instrumenter og slanger i luftveiene uten bruk av smøremiddel. Instrumenter og slanger uten smøremiddel kan også skade luftveiene.
- Luftveiene i Airway Head kan ikke steriliseres fullstendig, unngå av den grunn:
 - Munn-til-munn ventilering
 - Munn-til-maske ventilering
 - Innføring av simulert oppkast for utsuging

DK

Mål	
Vægt	3.18 kg
Understøttede værktøjer til luftvejshåndtering	
I-Gel (størrelse 5), LMA Classic (4 & 5), LMA Supreme (størrelse 3), Laryngeal Tube LTS-D (størrelser 3, 4 & 5), Japanese Sumi NA	
	Indeholder ikke latex

Garanti

Laerdal Resusci Anne Airway Head Upgrade Kit har to års begrenset garanti. Der henvises til Laerdals globale garanti vedrørende vilkår og betingelser.

Forsigtig

- Anvend kun det smøremiddel, der leveres af Laerdal Medical. Anvendelse af silikone eller andre smøremidler, der ikke er godkendt af Laerdal, kan beskadige luftvejene.
- Smør instrumenter og slanger før indsættelse i luftvejene. Det er vanskeligt at indsætte ikke-smurte instrumenter og slanger i luftvejene. Ikke-smurte instrumenter og slanger kan også beskadige luftvejene.
- Luftvejene i Airway Head kan ikke desinficeres fuldstændigt, og undlad derfor:
 - Mund-til-mund-ventilation
 - Mund-til-maske-ventilation
 - Indføring af simuleret opkast til udsugning



Important Product Information

FI

Mitat	
Paino	3.18 kg
Tuetut hengitysteiden hallintavälineet	
I-Gel (koko 5), LMA Classic (4 & 5), LMA Supreme (koko 3), Laryngeal Tube LTS-D (koko 3, 4 & 5), Japanese Sumi NA	
	Ei sisällä lateksia

Takuu

Laerdal Resusci Anne Airway Head Upgrade Kit -tuotteella on kahden vuoden rajoitettu takuu. Katso käyttöehdot Laerdal maailmanlaajuisesta takuusta.

Varoitukset

- Käytä ainoastaan Laerdal Medicalin toimittamaa liukastusainetta. Muun kuin Laerdalin hyväksymän silikonin tai muun liukastusaineen käyttö voi vaurioittaa hengitysteitä.
- Voitele instrumentit ja putket ennen niiden viemistä hengitysteihin. Voitelemattomia instrumentteja ja putkia on vaikea viedä hengitysteihin. Voitelemattomat instrumentit ja putket voivat myös vaurioittaa hengitysteitä.
- Ilmatiepään hengitysteitä ei voi täysin puhdistaa. Älä siksi käytä sitä
 - suusta suuhun -tekohengitykseen
 - suusta maskiin -tekohengitykseen
 - simuloidun oksennuksen lisäämiseen sen pois imemistä varten.

ZH

尺寸	
重量	约. 3.18 kg
支持的气道管理工具	
I-Gel (size 5), LMA Classic (4 & 5), LMA Supreme (size 3), Laryngeal Tube LTS-D (size 3, 4 & 5), Japanese Sumi NA	
	不含乳胶

注意事项

- 仅使用挪度气道润滑剂，使用未经挪度医疗批准的润滑剂可能损坏气道。
- 在插入其气道前润滑器械和导管。未经润滑的器械和导管很难插入气道，并可能造成气道损坏。
- 气道头部的气道无法彻底消毒，因此，勿：
 - 口对口通气
 - 口对面罩通气
 - 置入模拟呕吐物进行抽吸

保修

挪度复苏安妮气道头更新套装有两年保修期。请查看《挪度全球保修政策》了解条款和条件。



JA

寸法	
重量	約 3.18 kg
対応する気道管理ツール	
I-Gel (size 5), LMA Classic (4 & 5), LMA Supreme (size 3), Laryngeal Tube LTS-D (size 3, 4 & 5), Japanese Sumi NA	
ラテックスを含まない	

保証

レールダルレサシアンエアウェイヘッドアップグレードキットには、2年間の保証が付いています。諸条件については「Laerdalグローバル保証」をご参照ください。



注意

- Laerdal Medical 指定の潤滑剤のみを使用してください。Laerdal が許可しないシリコン潤滑剤またはその他の潤滑剤を使用すると、気道が破損する恐れがあります。
- 器具やチューブを気道に挿入する前に潤滑剤を塗布してください。器具やチューブに潤滑剤を塗布していない状態では、気道になかなか挿入できません。また、それにより気道が破損する恐れもあります。
- エアウェイヘッドの気道は完全に消毒することができないため、以下の処置を実施しないでください:
 - 口対人口呼吸
 - マスクを使つての人口呼吸
 - 吸引のための疑似嘔吐物の注入

KO

크기	
무게	약. 3.18 kg
지원되는 기도 관리 도구	
I-Gel (사이즈 5), LMA Classic (4 & 5), LMA Supreme (사이즈 3), Laryngeal Tube LTS-D (사이즈 3, 4 & 5), Japanese Sumi NA	
라텍스를 함유하지 않음	

보증

Laerdal Resusci Anne 에는 2년 제한 보증이 적용됩니다. 이용약관은 Laerdal 글로벌 보증서를 참조하십시오.



주의 사항

- Laerdal Medical 이 제공하는 윤활제만 사용하십시오. Laerdal 이 승인하지 않은 다른 윤활제를 사용하면 기도가 손상될 수 있습니다.
- 기도에 삽입하기 전에 기구 및 튜브에 윤활제를 바릅니다. 기구 및 튜브에 윤활제를 바르지 않으면 기도에 삽입하기가 어려울 수 있고, 기도가 손상될 수 있습니다.
- 기도 부분은 완전히 소독할 수 없기 때문에 다음과 같은 작업을 수행하지 마십시오.
 - 구강 대 구강 인공호흡
 - 흡입을 위한 인공 구토물 삽입
 - 흡인 실습을 위한 인공 구토물 삽입

© 2020 Laerdal Medical AS. All rights reserved.

Manufactured in China for:
Laerdal Medical AS
P.O. Box 377,
Tanke Svilandsgate 30, 4002 Stavanger, Norway
T: (+47) 51 51 17 00

Printed in China

20-17051 Rev A

www.laerdal.com



Laerdal
helping save lives